



***CEMLink***<sup>TM</sup>  
**Exploration of a Compliance Partnership**

**October 2, 2014**

# Compliance and Data Acquisition Systems

- Company/Experience Overview
- The VIM Experience
- Compliance Overview & Obligations
-  **CEMLink<sup>TM</sup>6** Software System

# Company Overview

- Established Stable Business (22 years)
- Software & Compliance Services Only Provider
- Corporate Office – Glen Burnie, MD
- Stable & Dynamic Work Environment

# Company Overview



# Company Overview

Our Compliance Partners include:

- Direct End User
- Industry Specific Corporate Sponsors
- CEMS Integrators
- Environmental Consultants

# Company Overview

- Broad industry background & application experience
- Power is the most significant market sector

- Duke Energy
- Cogentrix
- Dynegy
- NAES
- Others...

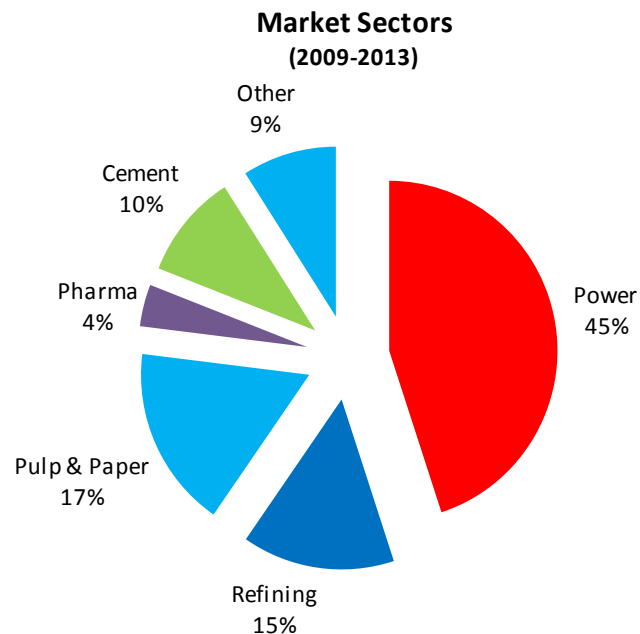

# The VIM Experience

- Expert in managing major projects
- Industry leader in supporting site-specific reporting
- Responsible Business Growth Model
- Interactive User Group (~450 members)

# Compliance Overview & Obligations

- Air Programs are defined at the Federal Level
- State Regulators are responsible for enforcement
- Local Regulators can drive additional requirements
- Corporations can “go beyond” to offset penalties



# Compliance Overview & Obligations

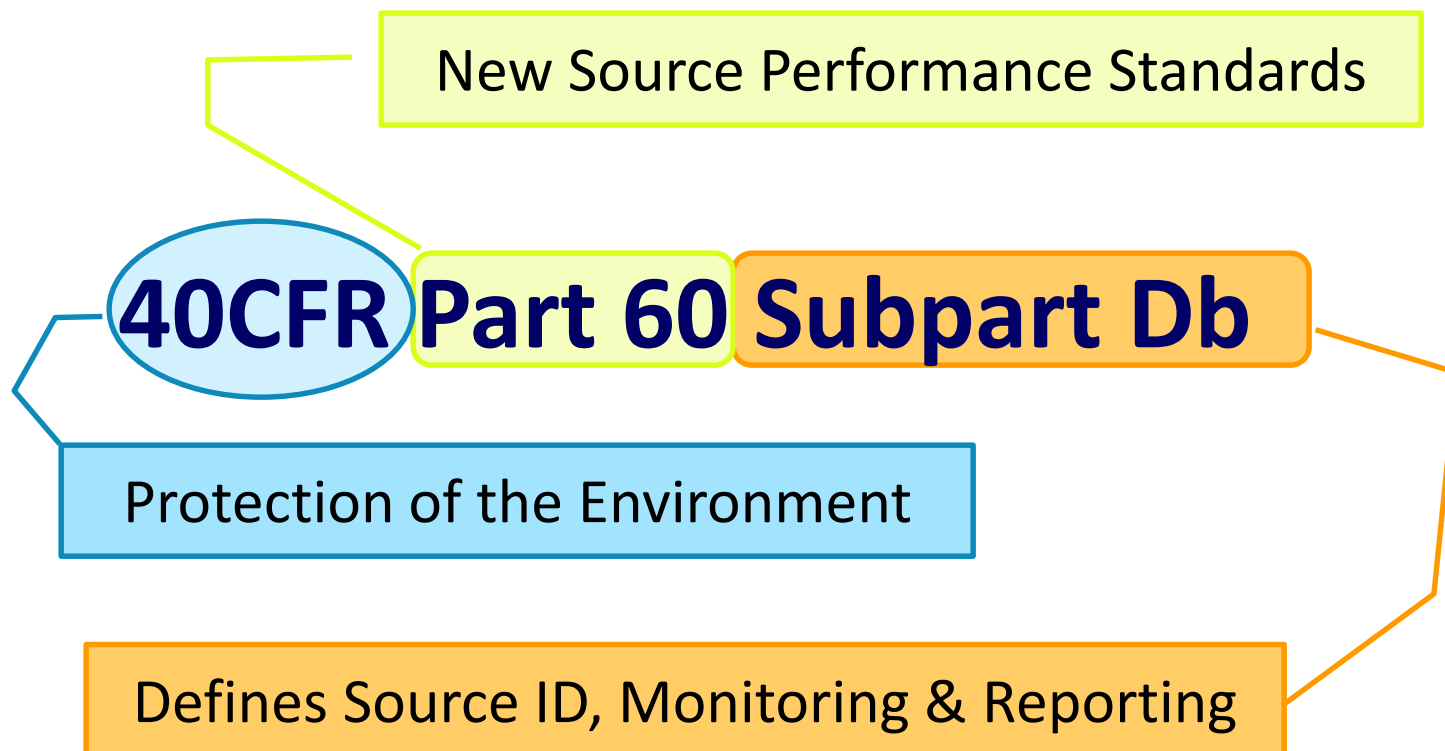

# Compliance Overview & Obligations

- NSPS – 40CFR Part 60 & Associated Subparts
- 40CFR Part 75 & Associated Subparts/Appendices
- South Coast Air Quality Management District (SCAQMD)
- Title V – Site Specific Operating Permit
- NESHAP - 40CFR Part 63 & Associated Subparts

# Compliance Overview & Obligations

- NSPS – 40CFR Part 60 & Associated Subparts
  - Criteria Pollutants
    - NO<sub>x</sub>/SO<sub>x</sub>/CO/CO<sub>2</sub>/O<sub>2</sub>/Opacity/Flow Component
- 40CFR Part 75 & Associated Subparts/Appendices
  - Criteria Pollutants
    - NO<sub>x</sub>/SO<sub>x</sub>/CO<sub>2</sub>/Opacity/Flow Component
    - XML EDR/Missing Data Routines

# Compliance Overview & Obligations

- SCAQMD (RECLAIM)
  - REgional CLean Air Incentive MArket Program
    - Comprehensive Regional Market Program
    - Defines financial incentives to reduce air emissions
    - Defines data availability and submission criteria
    - Annual Emission Reductions of NO<sub>x</sub> and SO<sub>2</sub>
    - Creates performance based tradable assets
    - Managed thru electronic submission of data

# Compliance Overview & Obligations

- Title V – Site Specific Operating Permit
  - Emission Limits
    - Normal Operating Conditions
    - SU/SD Conditions
  
- NESHAP - 40CFR Part 63 & Associated Subparts
  - Air Toxics
    - Mercury and industry ID specific
    - Particulate Matter (PM)

# Compliance Overview & Obligations

- Maintain emissions output within defined limits
- Installation of control technologies
- Demonstration of compliance
- Validate data and report quarterly

# Compliance Overview & Obligations

Data Validation Rules are the critical component

- ❖ Validity Rules
- ❖ Quadrant Rules
- ❖ Calibrations
- ❖ P/F Criteria
- ❖ Drift Tolerances
- ❖ Online vs Offline
- ❖ Status Flags

# Source ID & Site Overview

Criteria

MACT

RECLAIM

Emissions



Recovery Boiler

Power Boiler

Gas Turbine

Cement Kiln

FCCU



Production Material

Fuel

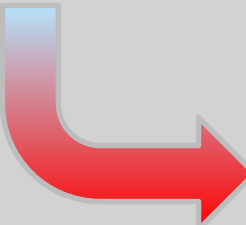

Air

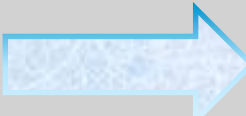

Processing

Raw Material







**CEMLink<sup>TM</sup>6**



- Microsoft Windows Server 2012 – 64 bit
- Microsoft SQL Server 2012 – 64 bit
- Microsoft .NET 4.0
- Microsoft WPF Client

Coal Boiler

Coal Boiler

Coal Boiler

Criteria

MATS

Criteria

MATS

Criteria

MATS

Flow

COMS

Flow

COMS

Flow

COMS



10-sec

1-min

6-min

15-min

1-hour

Initial Data Validations

DAS/DAHS/DARS



Database

Comp Calcs

Audit Logs

Agency Reports



# CEMLink™6

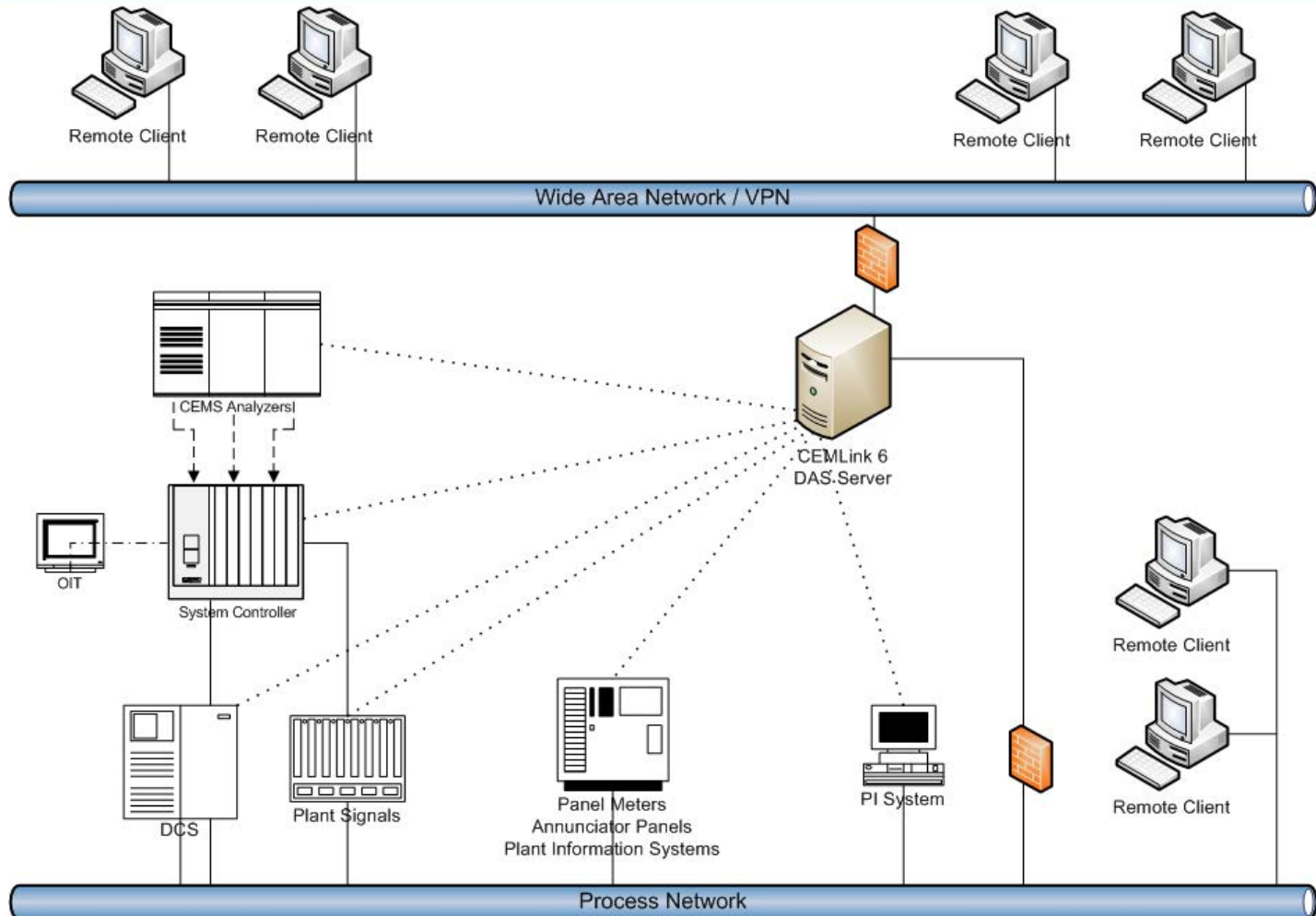

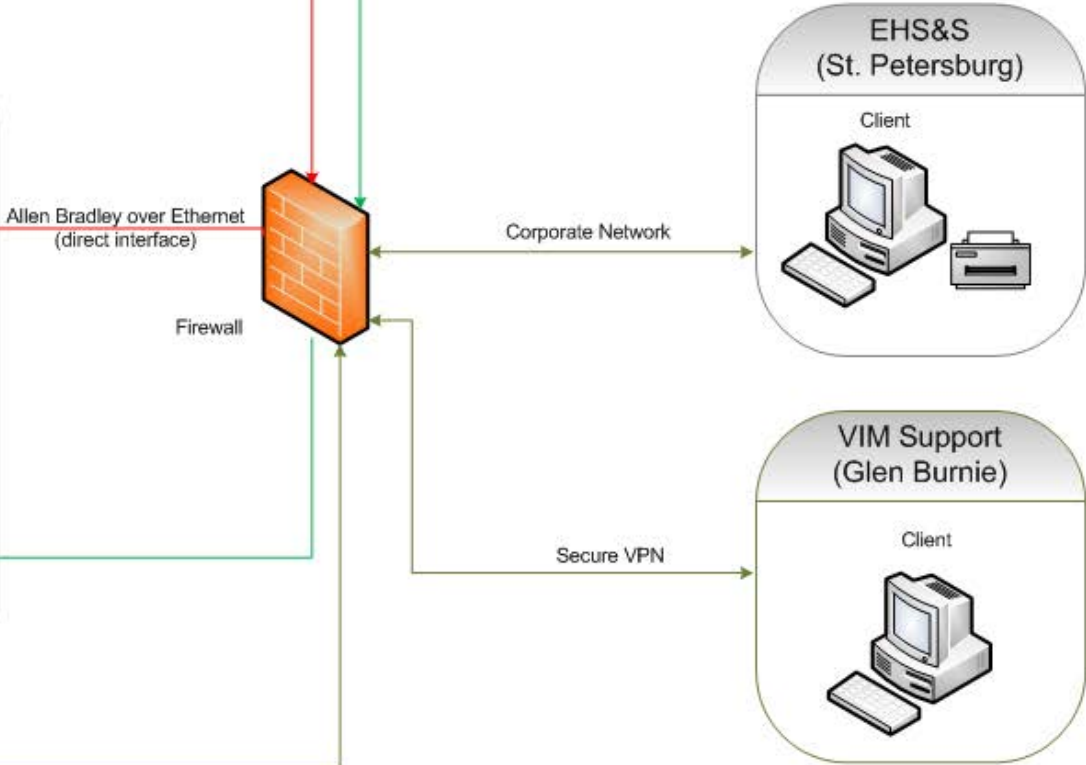
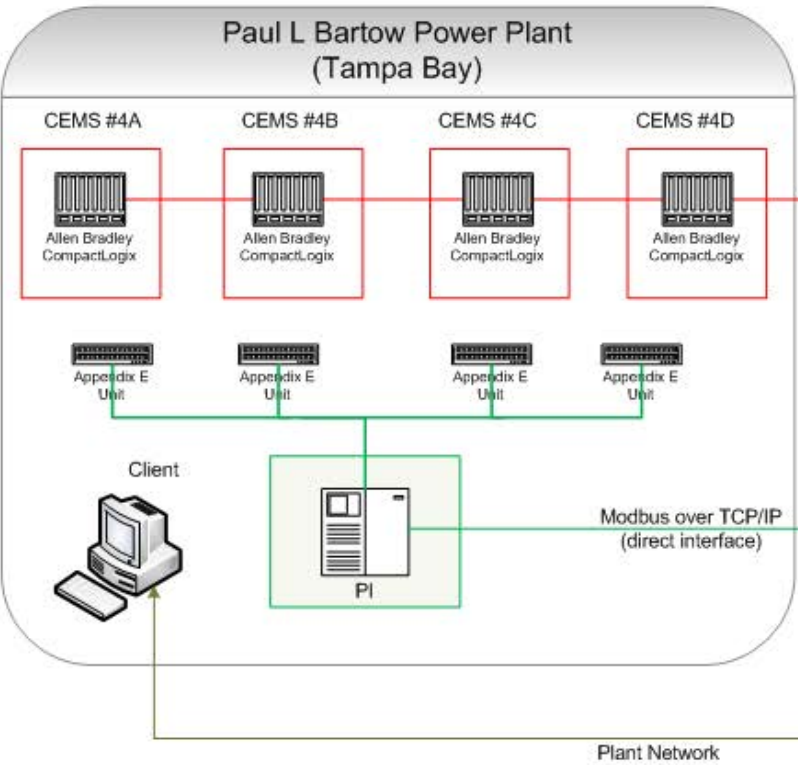
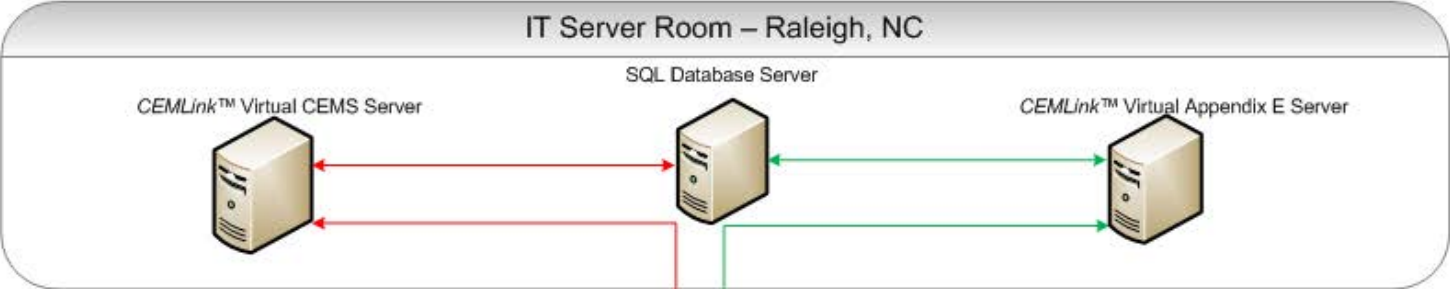

# Data Acquisition System (DAS)

Software Demonstration



# Questions ?

